

## Series PVR33N & PbF

Microelectronic Power IC  
HEXFET® Power MOSFET Photovoltaic Relay  
Dual-Pole, Normally-Open  
0-300V AC/DC, 165mA

### General Description

The PVR33 Series AC/DC Relay is a dual-pole, normally open, solid-state replacement for electromechanical relays used for general purpose switching of analog signals. It utilizes International Rectifier's HEXFET power MOSFETs as the output switches, driven by an integrated circuit photovoltaic generator of novel construction. The output switch is controlled by radiation from a GaAlAs light emitting diode (LED), which is optically isolated from the photovoltaic generator.

The PVR33 Series overcomes the limitations of both conventional electromechanical and reed relays by offering the solid state advantages of long life, fast operating speed, low pick up power, bounce-free operation, low thermal offset voltages and miniature package. These advantages allow product improvement and design innovations in many applications such as process control, multiplexing, automatic test equipment and data acquisition.

The PVR33 can switch analog signals from thermocouple level to 300 Volts peak AC or DC polarity. Signal frequencies into the RF range are easily controlled and switching rates up to 350Hz are achievable. The extremely small thermally generated offset voltages allow increased measurement accuracies.

These relays are packaged in 16-pin, molded DIP packages and available with thru-hole leads, in plastic shipping tubes.

### Features

- Bounce-Free Operation
- $10^{10}$  Off-State Resistance
- 1,000 V/ $\mu$ sec dv/dt
- 0.2  $\mu$ V Thermal Offset
- 5 mA Input Sensitivity
- 1,500 V<sub>RMS</sub> I/O Isolation
- Solid-State Reliability

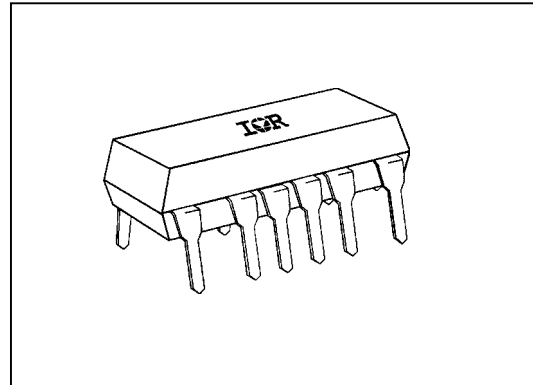

### Applications

- Process Control
- Data Acquisition
- Test Equipment
- Multiplexing and Scanning

### Part Identification

PVR2300N & PbF  
PVR3300N & PbF  
PVR3301N & PbF

*(HEXFET is the registered trademark for International Rectifier Power MOSFETs)*

**Electrical Specifications** ( $-40^{\circ}\text{C} \leq T_A \leq +85^{\circ}\text{C}$  unless otherwise specified)

INPUT CHARACTERISTICS		Units
Minimum Control Current A Connection (see figure 1) For 170 Continuous Load Current For 165 Continuous Load Current For 130 Continuous Load Current	2.0 5.0 5.0	DC mA@25°C mA@40°C mA@85°C
Minimum Turn-Off Current	10	μA(DC)
Minimum Turn-Off Voltage	0.6	V(DC)
Control Current Range (Caution: current limit input LED. See figure 6)	2.0 to 25	mA(DC)
Maximum Reverse Voltage	6.0	V(DC)

OUTPUT CHARACTERISTICS	PVR2300N	PVR3300N, PVR3301N	Units
Operating Voltage Range	±200	±300	V <sub>(peak)</sub>
Maximum Load Current 40°C I <sub>LED</sub> = 5mA (see figure 1)			
AC (A Connection)		165	mA (peak)
DC (B Connection)		180	mA(DC)
DC (C Connection)		310	mA(DC)
Response Time @25°C (see figures 7 and 8)			
Maximum T <sub>(on)</sub> @ 12mA Control, 100 mA Load, 100 VDC		150	μs
Maximum T <sub>(off)</sub> @ 12mA Control, 100 mA Load, 100 VDC		125	μs
Maximum On-state Resistance 25°C (Pulsed) (fig. 2) 50 mA Load, 5mA Control			
AC (A Connection)		24	Ω
DC (B Connection)		12	Ω
DC (C Connection)		6	Ω
Minimum Off-state Resistance 25°C @ 160 VDC PVR2300, PVR3300		10 <sup>9</sup>	Ω
@ 240 VDC PVR3301		10 <sup>10</sup>	Ω
Maximum Thermal Offset Voltage @ 5.0mA Control		0.2	μvolts
Minimum Off-State dv/dt		1000	V/μs
Typical Output Capacitance (see figure 9)		6	pF @ 50VDC

GENERAL CHARACTERISTICS		Units
Dielectric Strength: Input-Output	1500	V <sub>RMS</sub>
Insulation Resistance: Input-Output @ 500V <sub>DC</sub>	10 <sup>12</sup>	Ω
Maximum Capacitance: Input-Output	1.0	pF
Maximum Lead Soldering Temperature (1.6mm below seating plane for 10 sec.)	260	°C
Ambient Temperature Range:	Operating	-40 to +85
	Storage	-40 to +100

International Rectifier does not recommend the use of this product in aerospace, avionics, military or life support applications. Users of this International Rectifier product in such applications assume all risks of such use and indemnify International Rectifier against all damages resulting from such use.

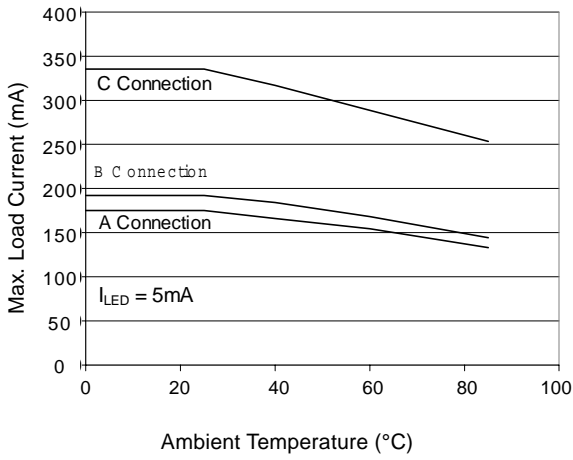

Figure 1. Current Derating Curve

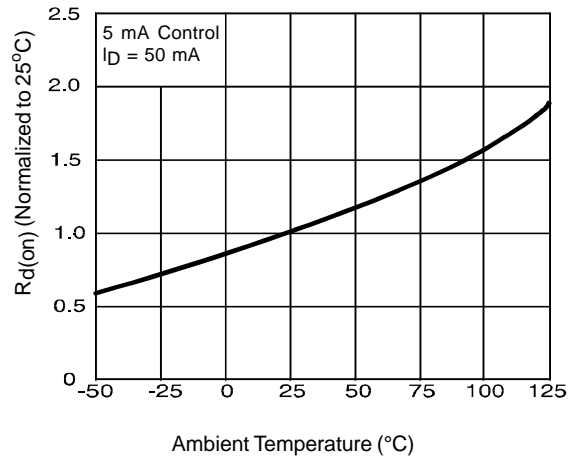

Figure 2. Typical On-Resistance

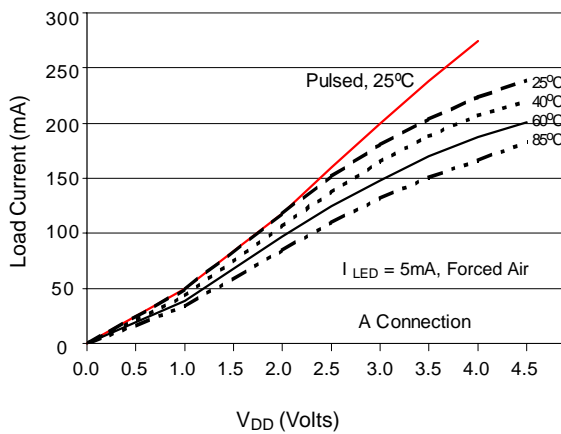

Figure 3. Typical On-Characteristic A Connection

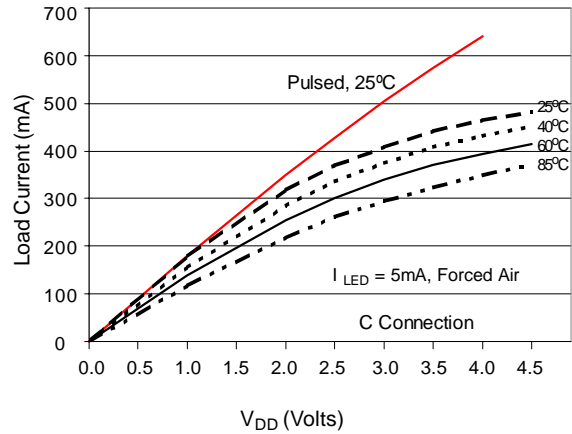

Figure 4. Typical On-Characteristic C Connection

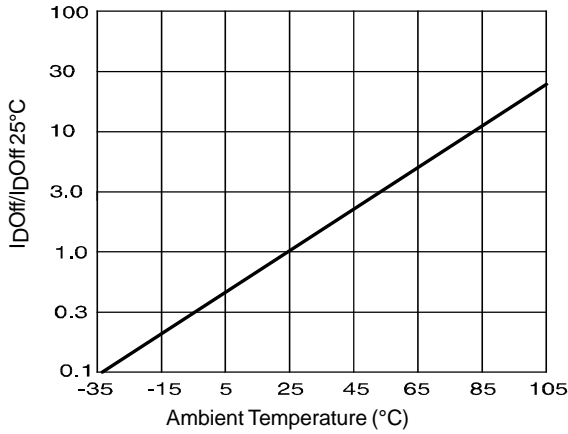

Figure 5. Typical Normalized Off-State Leakage

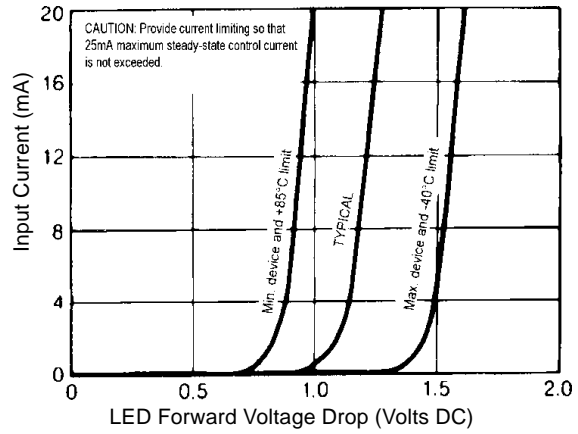

Figure 6. Input Characteristics (Current Controlled)

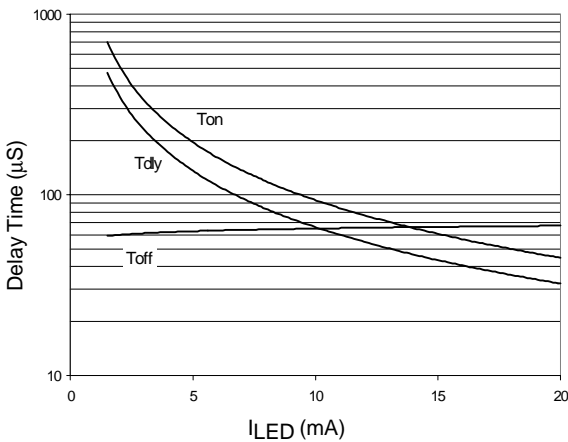

Figure 7. Typical Delay Times

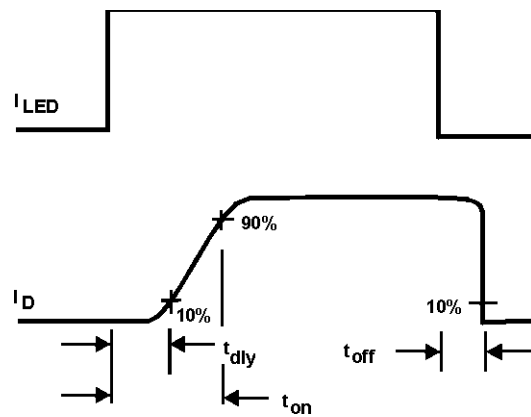
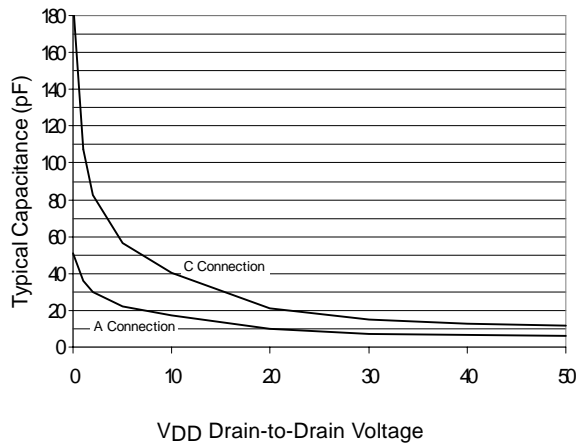

Figure 8. Delay Time Definitions



**Figure 9. Typical Output Capacitance**

**Wiring Diagram**

**Schematic Diagram**

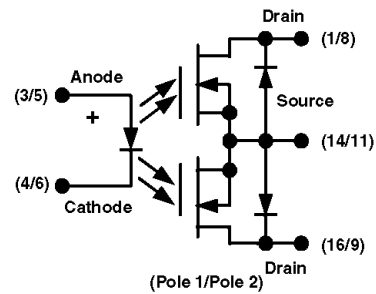
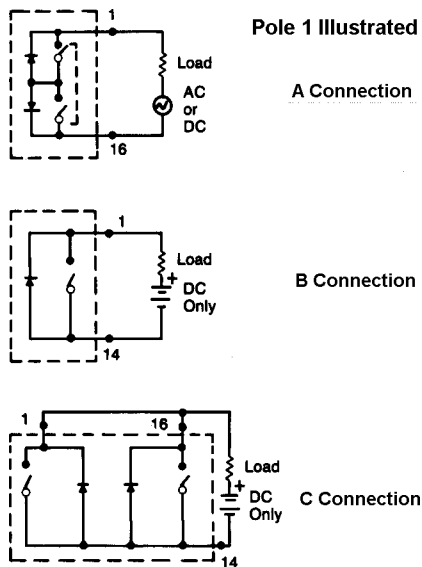

**Case Outline**

